

D

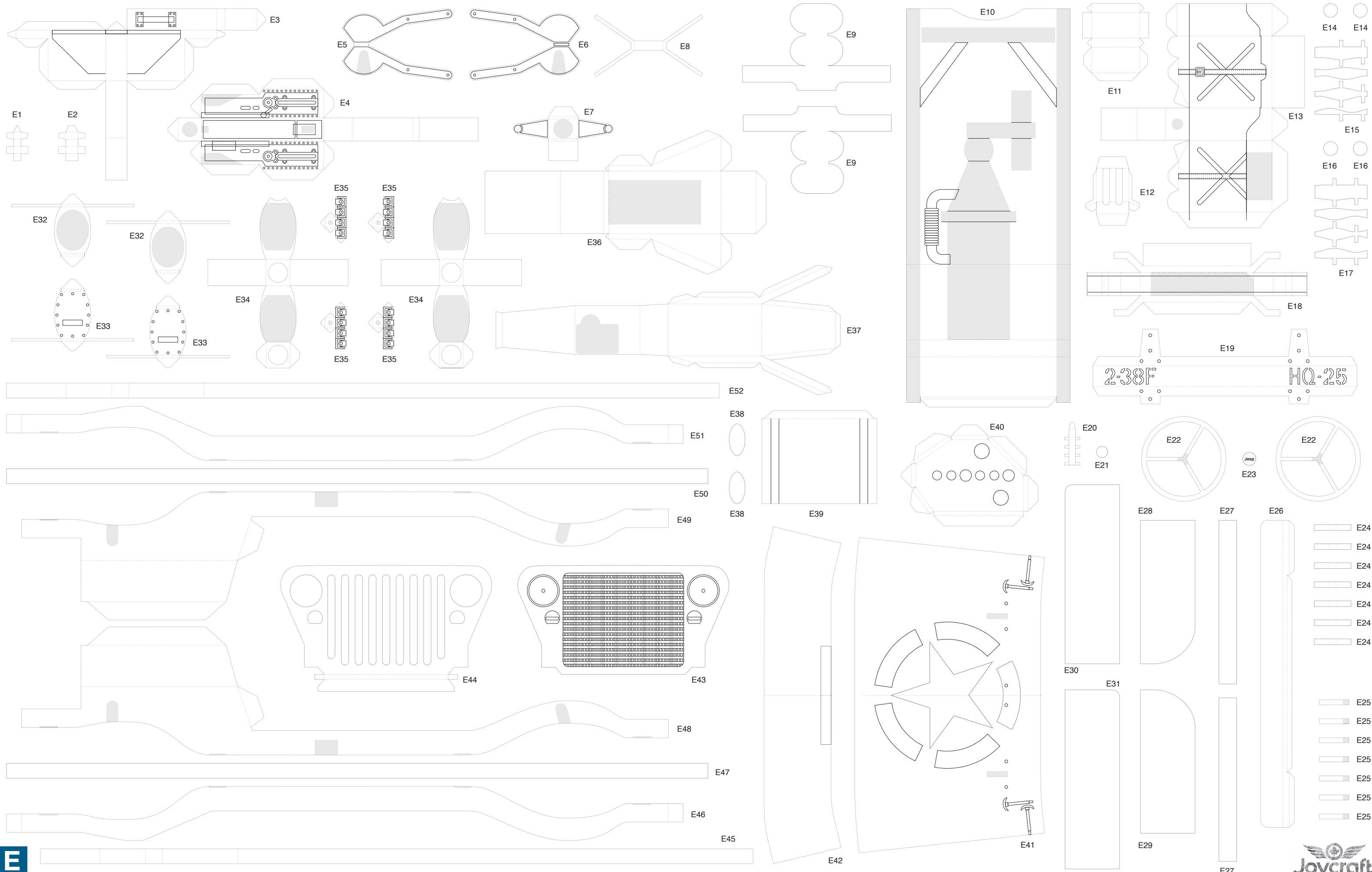

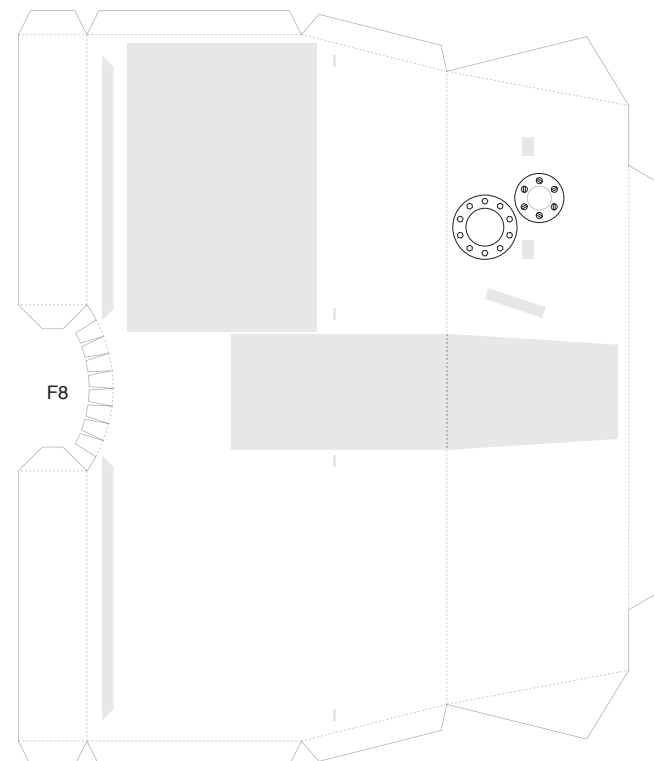

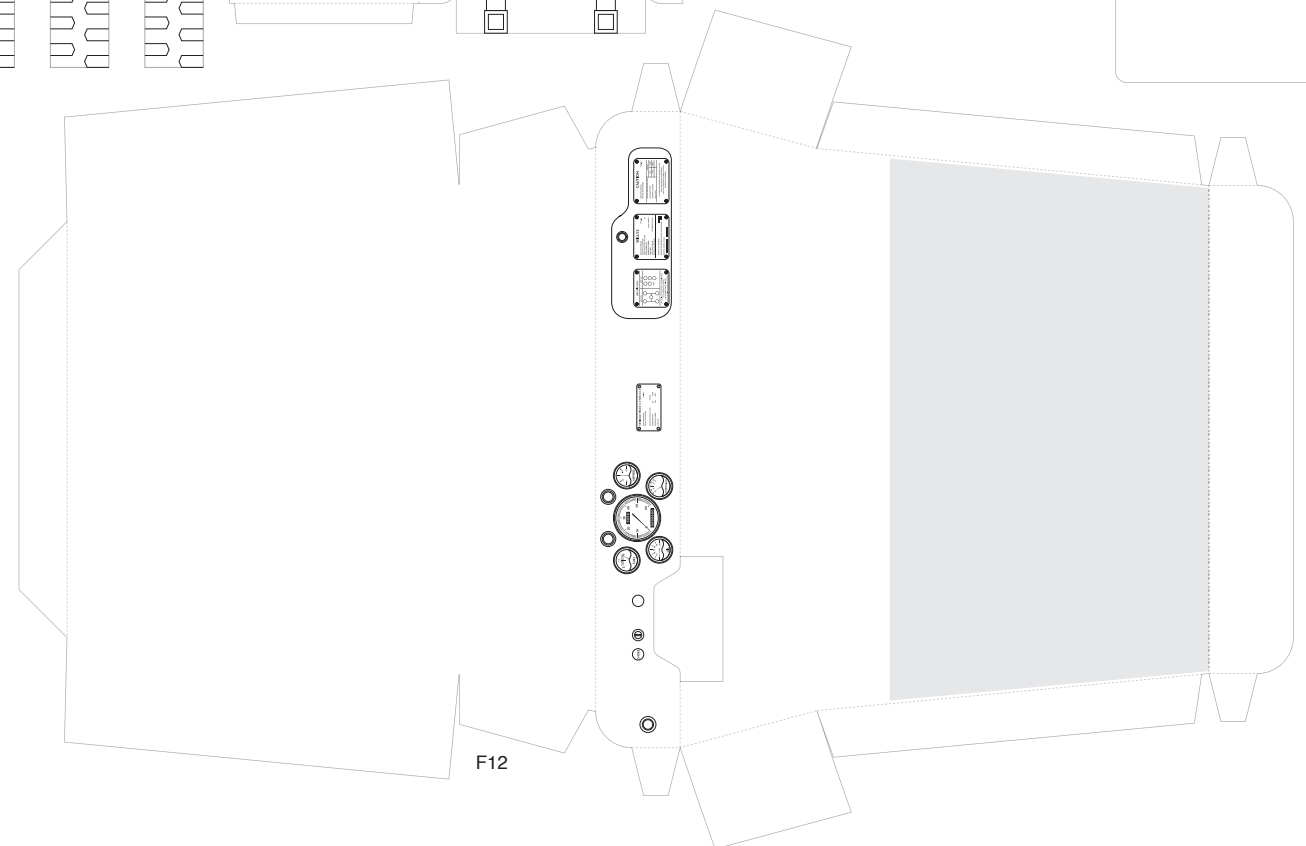
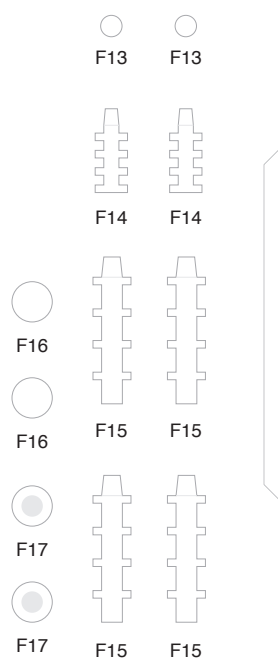
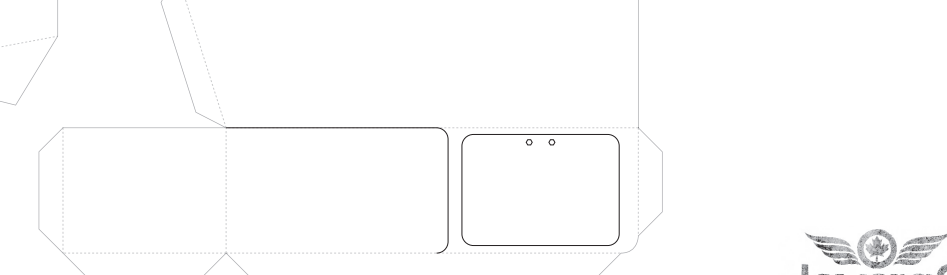
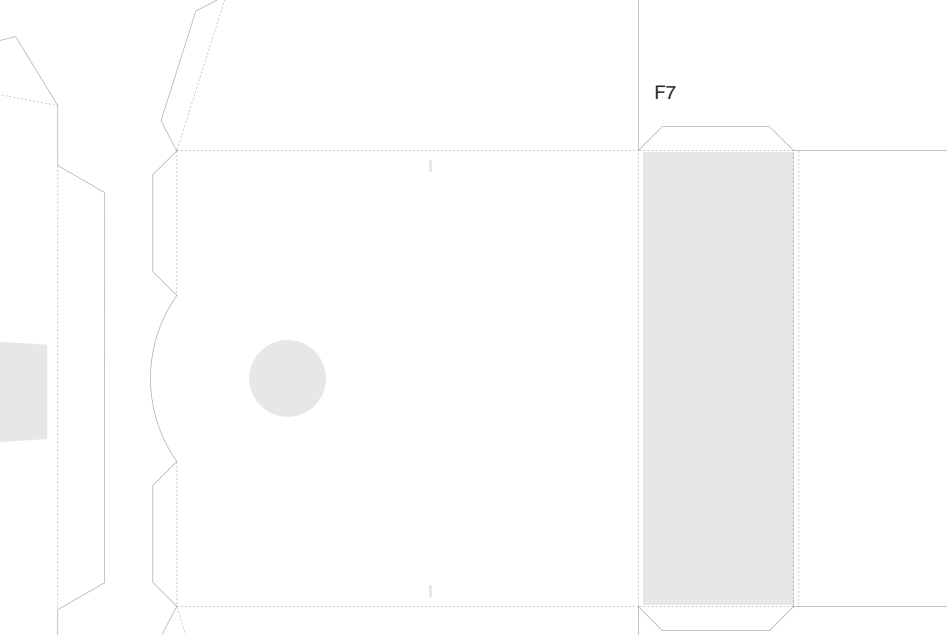
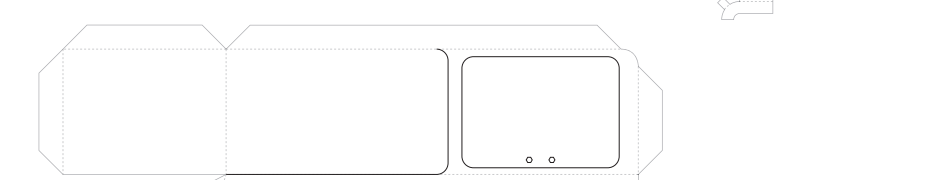
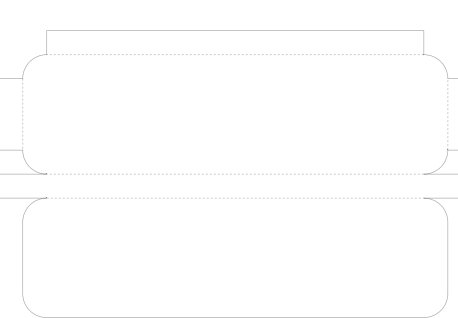
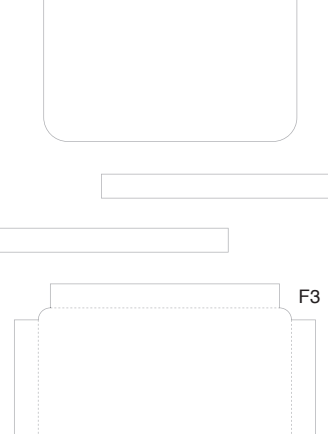
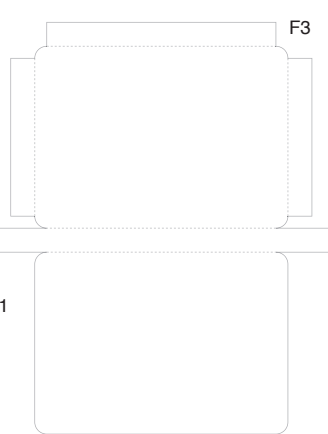
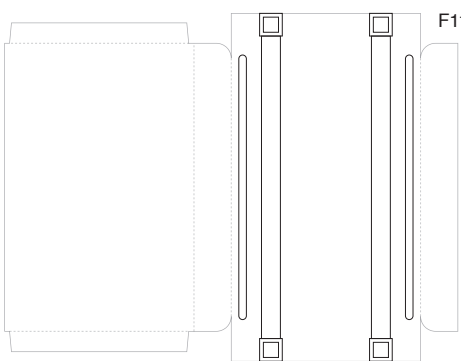
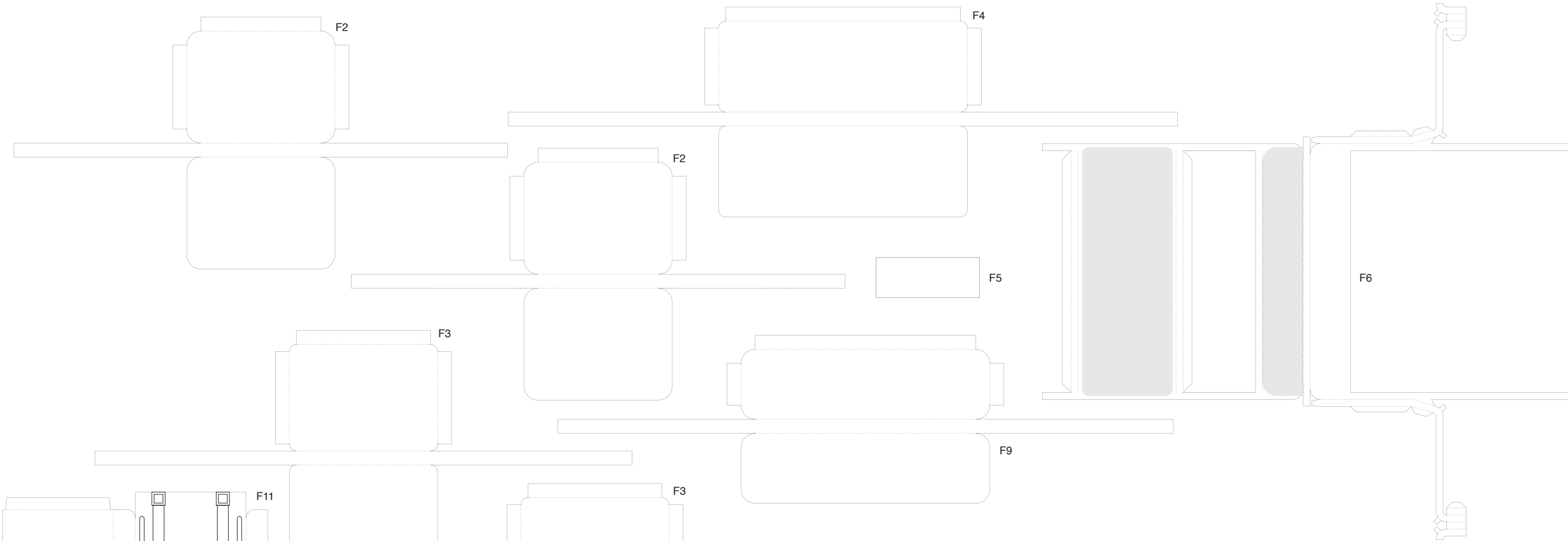
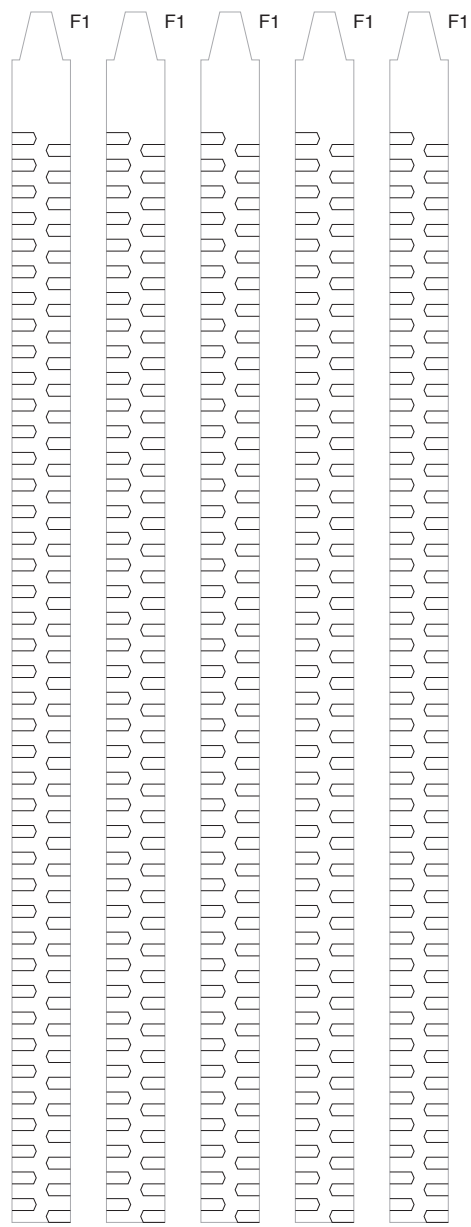
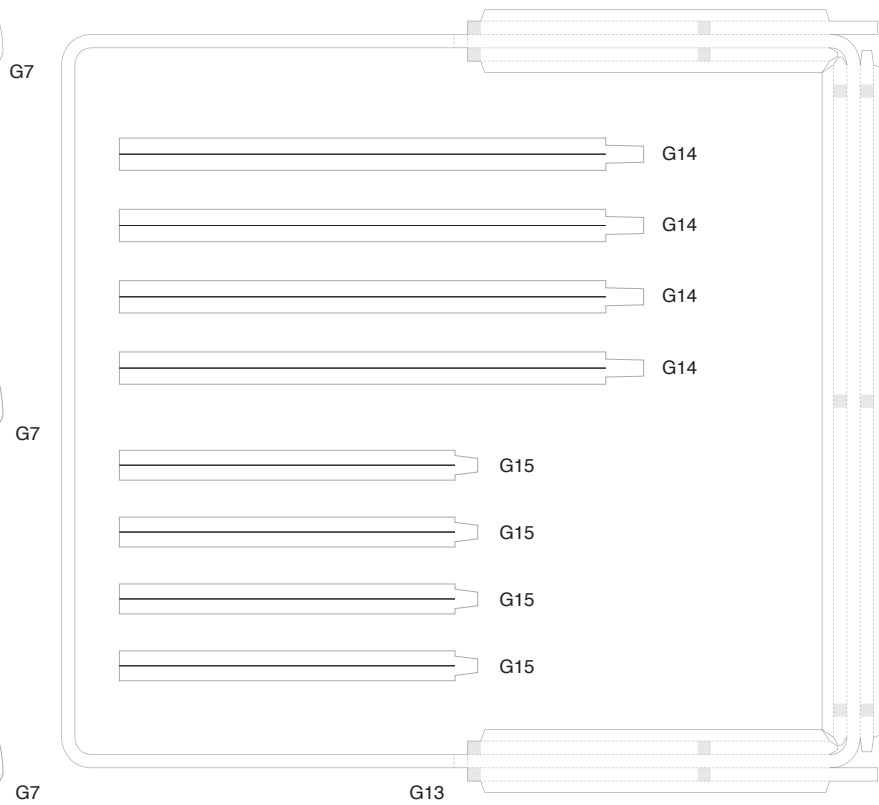
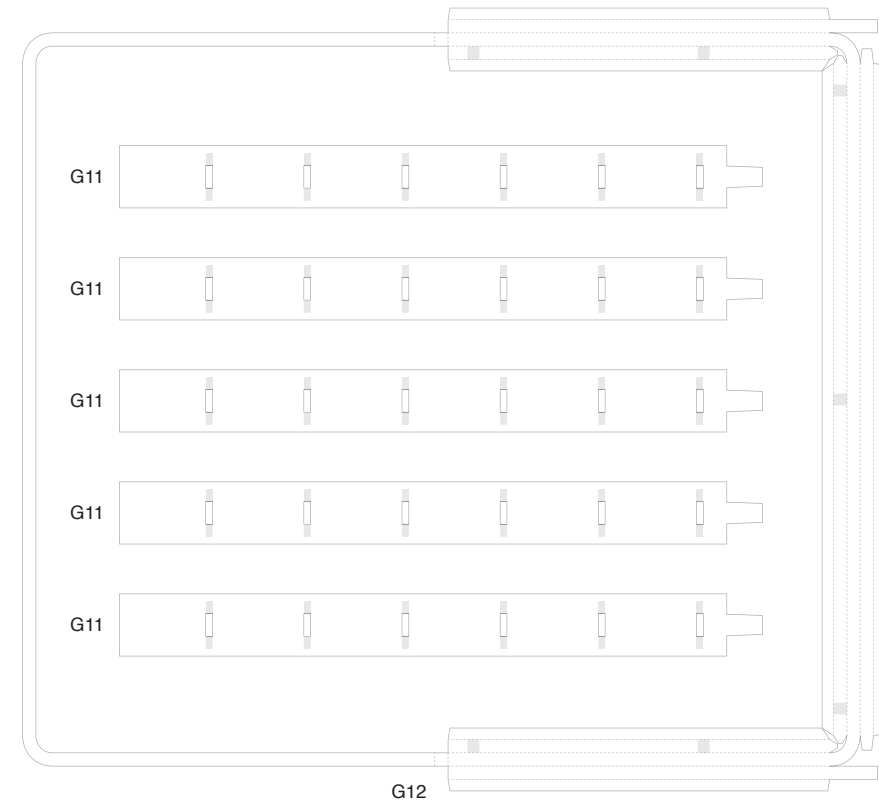
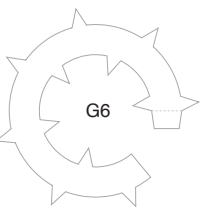
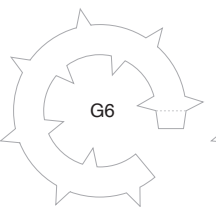
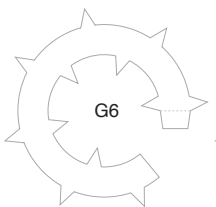
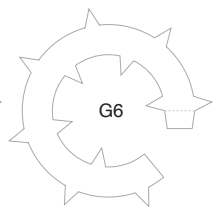
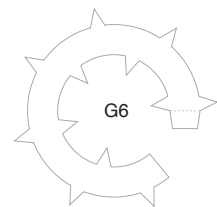
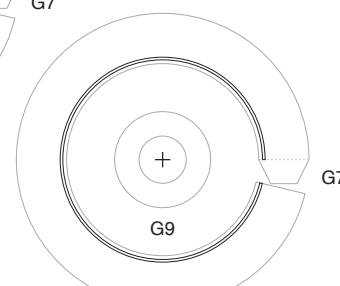
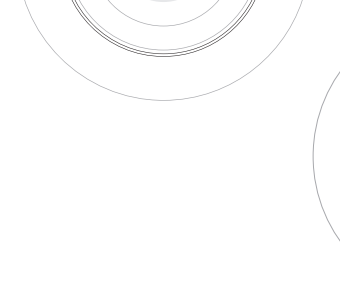
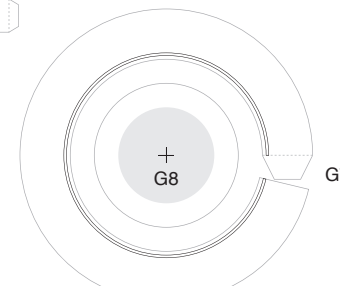
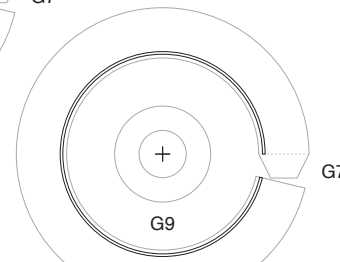
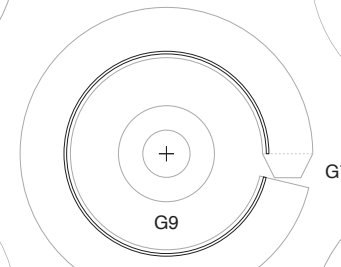
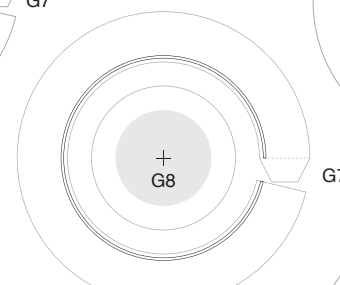
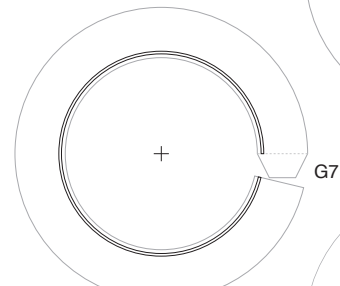
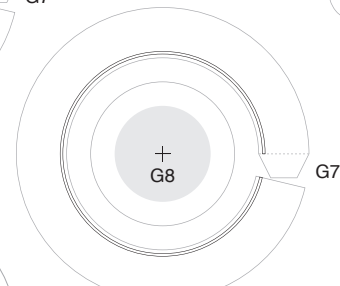
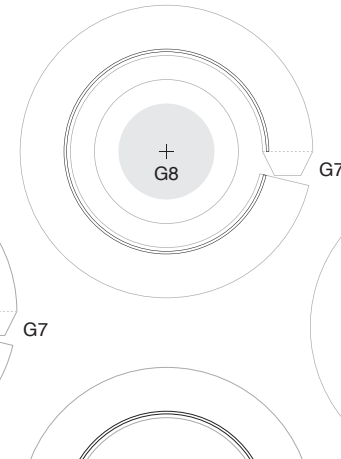
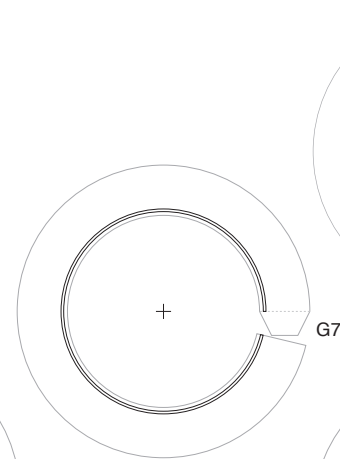
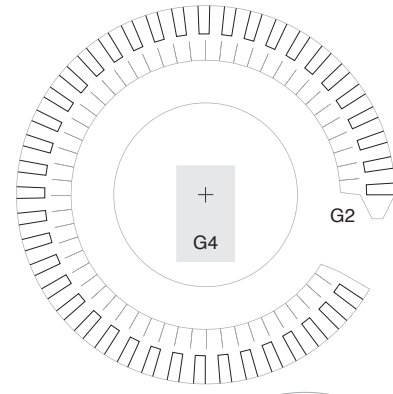
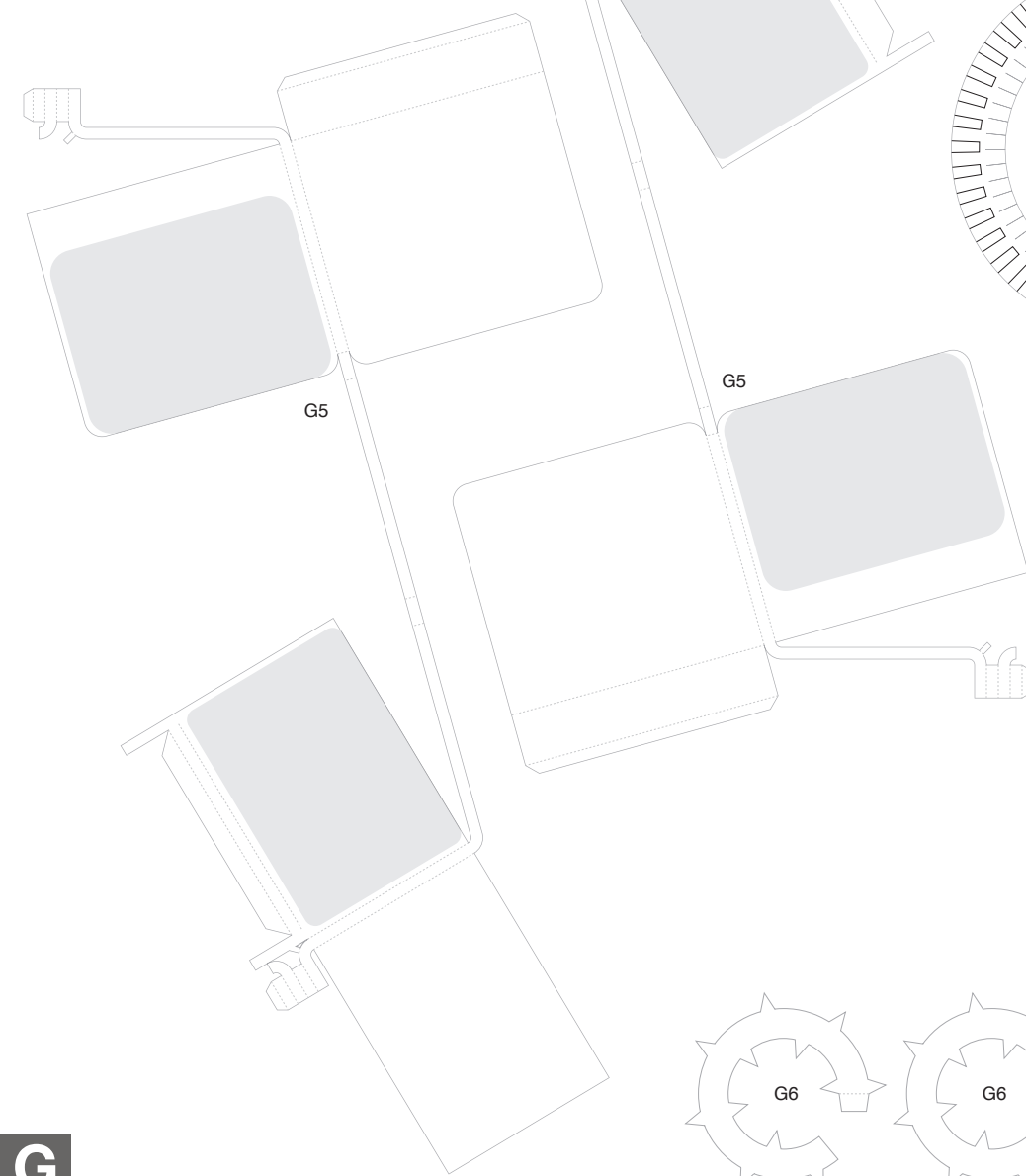
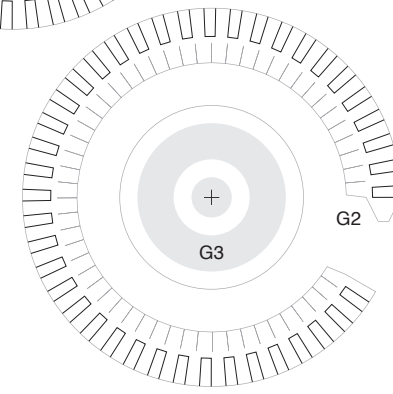
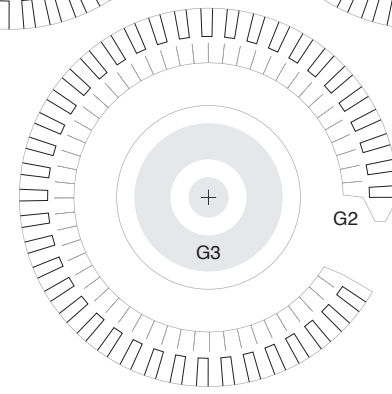
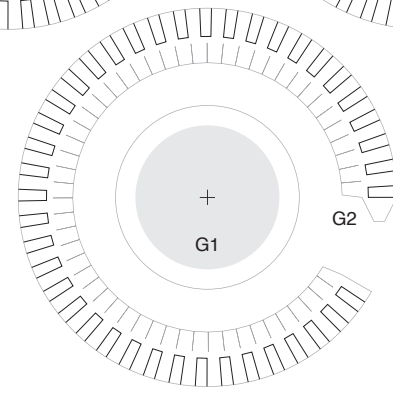
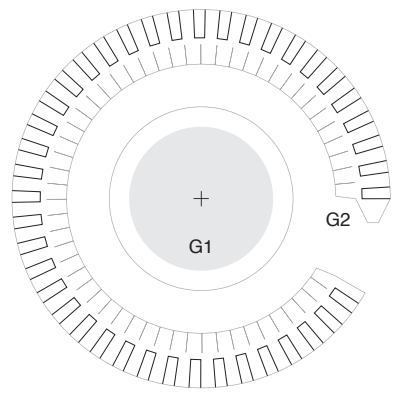
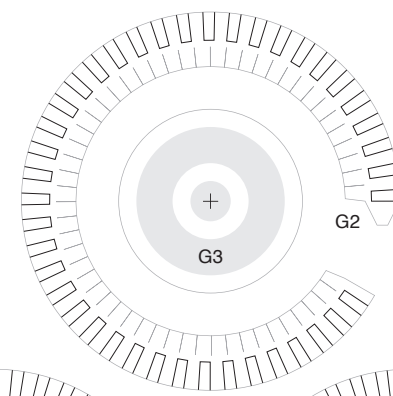
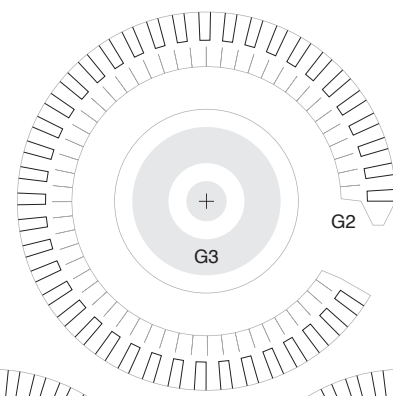
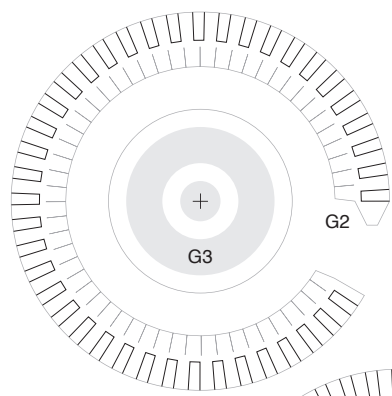
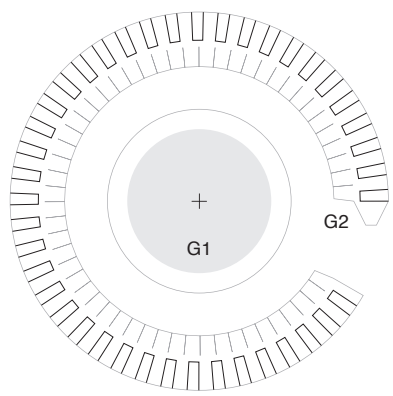
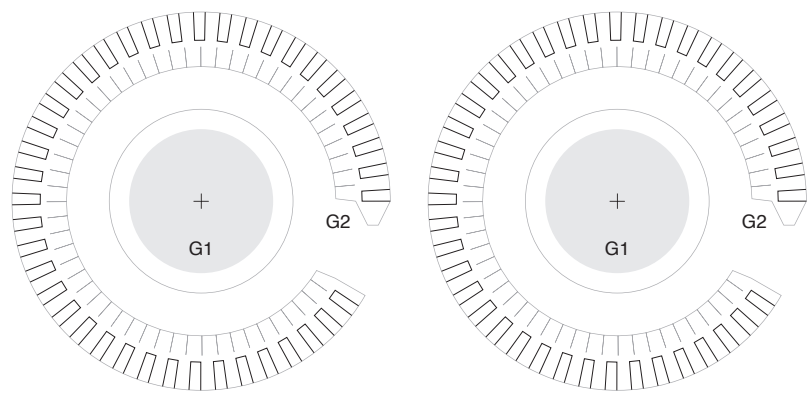

G16 □ □ G16
G16 □ □ G16